

GOODWE



INSTALLATION MANUAL

GOODWE PVBM

UP TO A SUSTAINABLE FUTURE

SUNSHINE MH

BMT-S2-032A

CONTENTS

1

DESCRIPTION OF THE
MAIN STRUCTURE
OF SUNSHINE MH

P3

2

INSTALLATION
ACCESSORIES LIST

P4

3

INSTALLATION
TOOLS LIST

P5

4

SAFETY WARNING

P6

5

INSTALLATION
WORK

P7

6

ELECTRICAL
INSTALLATION

P20

7

ELECTRICAL
CONSTRUCTION
PROCESS

P25

8

REMOVAL AND
MAINTENANCE

P29

9

CAUTIONS

P31

1

DESCRIPTION OF THE MAIN STRUCTURE OF SUNSHINE MH



Sunshine MH Black version



Sunshine MH Grey version

Installation Altitude <2000m

Fire Protection Level: CLASS A (IEC 61730-2-MST23)

Protection Level: Level II

Maximum Mechanical load: Front 5400Pa; Back 2400Pa

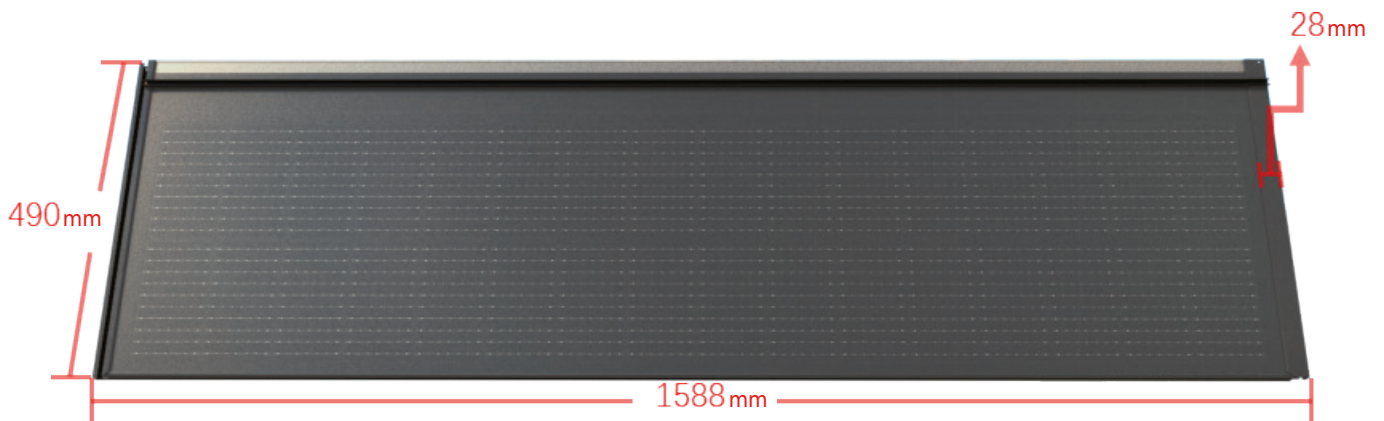

Dimension: As shown below

2

INSTALLATION ACCESSORIES LIST

SUNSHINE MH MOUNTING KIT (STANDARD)



PLUG (OPTIONAL)



GROUNDING KIT (OPTIONAL)

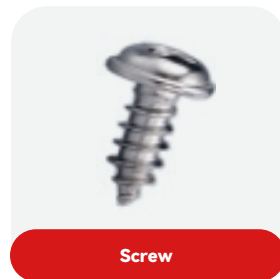
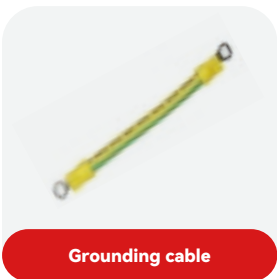

METAL TILE ACCESSORIES

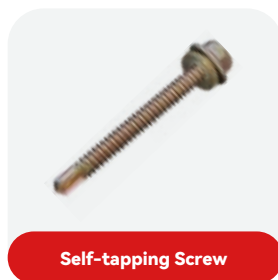
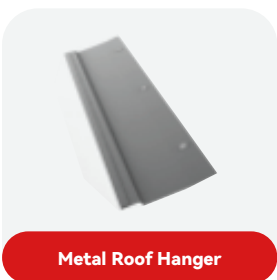

3

INSTALLATION TOOLS LIST



Tape Measure



Electric Impact Wrench



Chalk Line

Cutting Machine (with
woodworking saw blades and
stone saw blades)Magnetic Crosshead
Screwdriver Bit, length≥100mm

Claw Hammer



Suction Cup



Utility Knife

Note: This list only indicates the main tools required for the installation of Sunshine Tile structure system and does not include the tools used for the installation of the roof support section and the electrical section.

The tools used for the installation of the roof brackets can be referred to the preparation of the building work.

ELECTRICAL INSTALLATION TOOL LIST



Needle Nose Pliers



Wire cutter

Photovoltaic special
crimping pliers

Wire stripping pliers



Joint wrench

4

SAFETY WARNING



WARNING

- Sunshine MH products can generate electricity under sunlight, so it is strictly forbidden to short-circuit the output cables, otherwise the cables may overheat and cause the cable sheath to melt.
- During installation, construction workers should wear non-slip shoes or shoe covers and have reliable fall protection.
- Installation should be stopped during rainy weather, when the roof is wet, or when the ground is wet to prevent the risk of falls or electric shock.



BE CAREFUL

- DO NOT lift Sunshine MH products by dragging its adhesive strips, junction boxes, or cables during handling, as it may cause the damage or detachment of these components.
- Dropping Sunshine MH products during handling may cause the breakage of the products.
- DO NOT twist Sunshine MH products during installation as it will damage the product or cause other injuries.
- DO NOT pull the output cables around the Sunshine MH frame and support during installation, as it can cause short circuits or fires.
- DO NOT bring the product into direct contact with any rigid material, as this will cause them to break.
- The product should be installed on a roof pitched 5° to 45° to ensure roof water tightness, otherwise water leakage may occur.
- The absolute length deviation of the matching cement tiles should be $\leq 4\text{mm}$, and the absolute width deviation should be $\leq 3\text{mm}$.
- When construction is interrupted, waterproof protection should be provided for unconnected cable connectors.
- During roof construction, surface protection for Sunshine MH products should be provided to avoid contamination from cross-construction with materials like paint, which can affect product appearance and electricity generation.

5

INSTALLATION WORK

5.1 UNPACKING AND STACKING

1. Sunshine Tiles must be shipped in the boxes provided by GoodWe and should be stored in the original boxes before installation. Please protect the package from damage. Follow the recommended unpacking procedure to open Sunshine MH products' package. Careful handling is required during unpacking, transportation and storage.
2. Check whether the box is damaged before unpacking.
3. Do not stack Sunshine Tiles flat or pile them up on the ground.
4. When placing the Sunshine Tiles on site temporarily, they should be placed vertically against a solid surface with a max number of tiles of 15 pcs per stack.
5. The connecting cables should not be squeezed between two Sunshine Tile frames to avoid cable damage due to compression.
6. Uninstalled Sunshine Tiles should be protected against water or humidity during installation.

5.2 SUBSTRATE INSPECTION

1. The substrate must be solid and free from defects such as looseness, bulging, pitting, sanding, and shedding of dust. Depressions and cracks should be filled and smoothed with cement mortar.
2. The substrate should be flat, dry and clean. The surface should be smooth and uniform. Its flatness can be checked with a 2m straight edge and the maximum gap between the straight edge and the substrate should not exceed 10mm. Gaps are only allowed to change gradually and are not permitted to have abrupt variations.
3. The maximum deviation of the overall flatness of the concrete cast-in-place roof leveling layer should not exceed $\pm 5\text{mm}$; the ridges, oblique ridges, and drainage ditches should be made into contour strips. After the leveling layer is constructed, it should be cured for 3 to 7 days before subsequent procedures can be carried out.
4. After the treatment of the base layer of the roof, the surface flatness, verticality of the elevation, obtuse and acute angles and squareness all need to meet the requirements of the

5.3 LAYING WATERPROOF MEMBRANE

1. Substrate treatment: The base surface should be firm, dry and clean (free of dust and oil stains), with any raised areas leveled and any depressions or cracks filled with polymer mortar.

2. Application of base treatment agent: The container holding the treatment agent should be thoroughly stirred after opening. Begin by applying the agent with a brush around the edges, corners, and joints of the base layer. Subsequently, utilize either brushing or spraying techniques for the application on the base layer. The spray should be even and consistent. After drying, the surface should be kept clean. If it becomes contaminated, it should be rebrushed and treated, and the adhesive roll material should be applied promptly after drying.
3. The direction of laying the roll material should comply with the following regulations:
 - ① When the slope of the roof is less than 3%, the roll material should be laid parallel to the ridge of the roof.
 - ② When the slope of the roof is between 3% and 15%, the roll material can be laid parallel or perpendicular to the roof ridge.
 - ③ When the slope of the roof is greater than 15% or the roof is subject to vibration, the asphalt waterproof roll material should be laid perpendicular to the roof ridge, and the high polymer modified asphalt waterproof roll material can be laid parallel or perpendicular to the roof ridge.

Detail Processing: For the eave's trough, deformation joint, flashing, and roof outlet extending through the roof pipe, the reference for roof access points should follow local roof engineering technical specifications for processing. The parts requiring reinforcement or additional layers should be set according to local regulations.

4. Waterproof membrane overlapping:
 - Vertical overlapping distance: minimum 80mm
 - Horizontal overlapping distance: minimum 100mm
 - (the isolation paper on the overlapping edge must be removed)
 - ① Firstly, align the waterproof membrane with the baseline and spread it out completely. Roll up the membrane (along with the isolation paper) from one end, fold it along the middle line of the roll material, and lightly scratch the backside isolation paper of the roll material with a paper cutter. Carefully tear off a section (about 500mm) and align the torn-off section of the waterproof membrane with the baseline. Then, re-spread the waterproof membrane that has been lifted. Pull the isolation paper evenly and firmly backwards. Slowly pull out all the isolation paper of the waterproof membrane and press and stick the roll material firmly. Repeat the process to stick the waterproof membrane left. During the pulling and laying process, always pay attention to the integrity of the isolation paper. If any tears or broken has been found, the laying process should be stopped immediately. After cleaning up the torn residual isolation paper, continue with the construction.
 - ② Vertical surface tiling: The surface should be tiled from bottom to top, and the isolation paper should be peeled off while unfolding the waterproof membrane. The node positions should be covered with an additional waterproof layer according to local regulations. The waterproof membrane should be immediately pressed with a rubber roller after tiling.



5. Construction inspection:

- ① Check for any tears, damage, bubbles, curling or opening in all self-adhesive rolls. If there are defects, cut open the defective part, remove the bubbles, then reapply and press firmly.
- ② Add a waterproofing layer to the ridge with a width of no less than 500mm.
- ③ The waterproofing layer should be laid and overlapped in the direction of water flow.
- ④ An additional layer should be added to the waterproofing layer at the eaves. In cold areas or high wind areas, a self-adhesive polymer-modified asphalt waterproofing layer should be used, with a downward folding width of no less than 100mm and a roof installation width of no less than 900mm.
- ⑤ The metal flashing should be installed on the additional layer of the waterproofing layer and extend into the eaves.
- ⑥ A waterproofing layer should be installed on the metal flashing.
- ⑦ An additional layer should be added to the waterproofing layer at the gutter.
- ⑧ The additional layer of the waterproofing layer should be extended and laid into the concrete gutter.
- ⑨ An additional layer should be added to the waterproofing layer along the centerline of the valley, with a width of no less than 1000mm.
- ⑩ The waterproofing layer at the gable wall, vertical wall, parapet wall and other parts should be fully adhered, extending upward along the vertical wall by no less than 250mm.

5.4 FIXING LAYER CHECKING

Before the installation of counter battens and battens, please check the fixing layer of the roof to ensure its smoothness, sufficient thickness and strength, to ensure a secure installation.

5.5 LEVELLING, SCREEDING AND STRING LINING:

Based on the characteristics and actual size of the tiled roof, mark the position lines for the counter battens and battens. The counter battens and battens made of wood should use Grade I or Grade II wood with a moisture content not exceeding 18% and should be treated for anti-corrosion and anti-insect. The connection between the rafters and the holding layer and between the battens and the rafters should be securely fixed.

5.6 INSTALLATION OF COUNTER BATTENS AND BATTENS:

1. The specification of the counter batten should not be less than 40*30(H)mm (optional specifications).
2. The counter batten should be nailed firmly, straight and flat, with a spacing of 450-600mm, as shown in the figure below.
3. The minimum specification of battens is 30mm*30mm wooden batten (Optional specifications, please make sure the batten used in the project is no less than the size mentioned).
4. The thickness of the eaves battens should be appropriately increased.
5. The center distance between two battens should be 400-440±5mm. The battens should be laid and nailed firmly, straight and flat, with a smooth surface (As shown in the figure below).

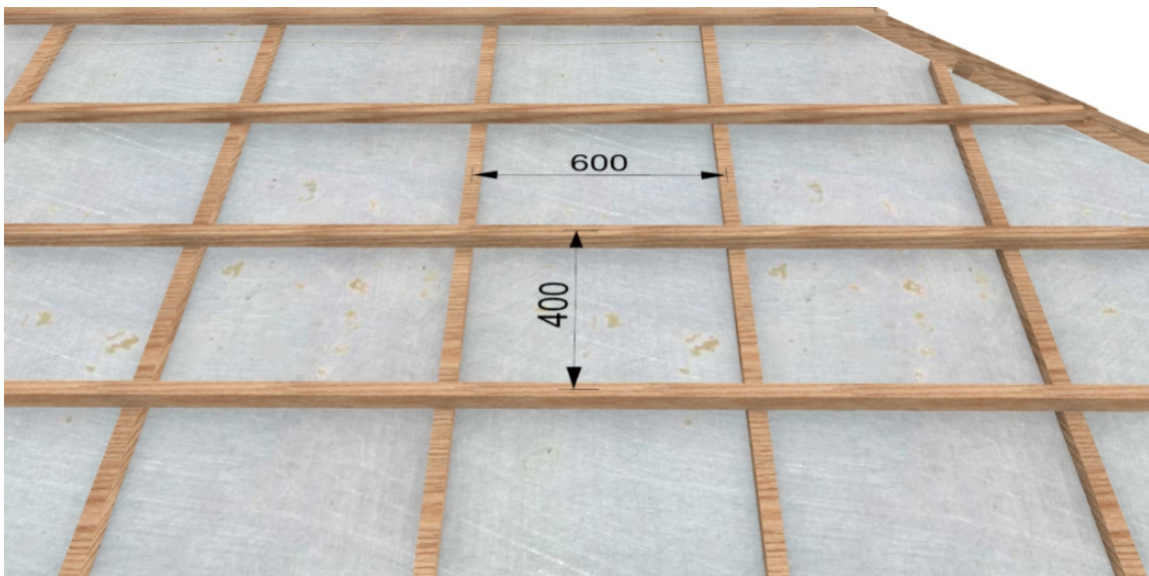

Installation of counter battens and battens

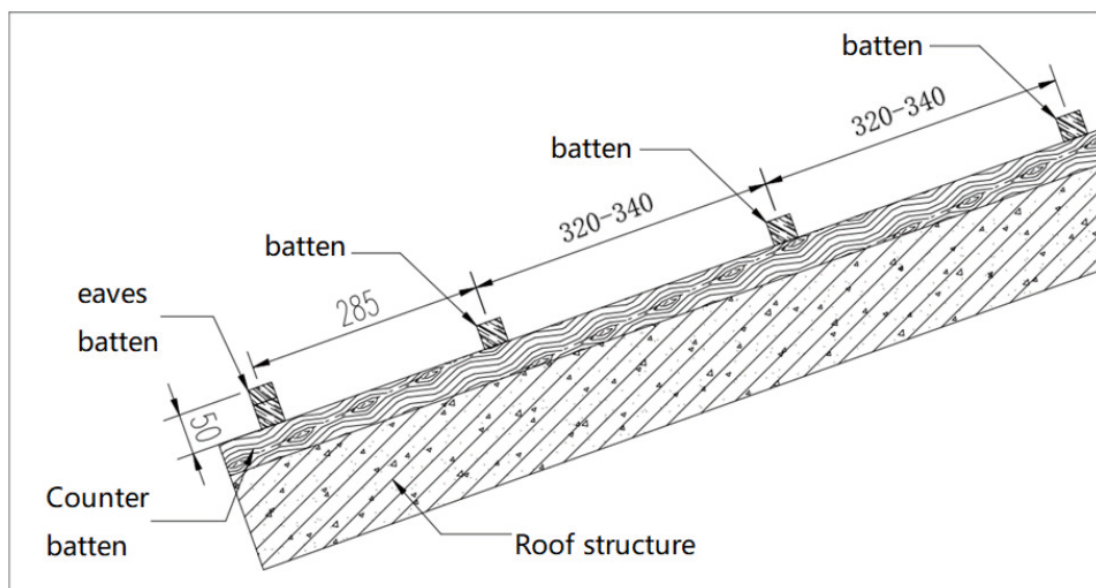

Sectional view of battens

5.7 INSTALLATION WORK OF THE SUNSHINE TILE

The overall installation sequence is from right to left for the same row, from bottom to top row by row.

1. First install the matching tiles at the eaves position of the roof, with the installation sequence from right to left and from bottom to top (as shown in the figure below).

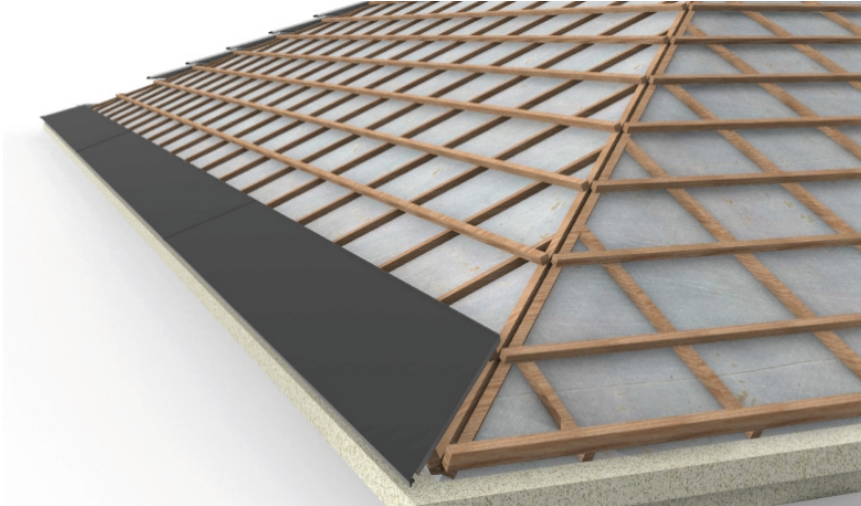

2. Install the Sunshine MH products row by row from bottom to top. When installing the Sunshine MH products, determine the position of the installation hook according to the design plan, and install the hook on the lower side of the Sunshine MH product. Each Sunshine MH product requires 2 installation hooks and 4 installation screws. The position relation of the installation hook and the Sunshine MH product side is shown in the figure below.

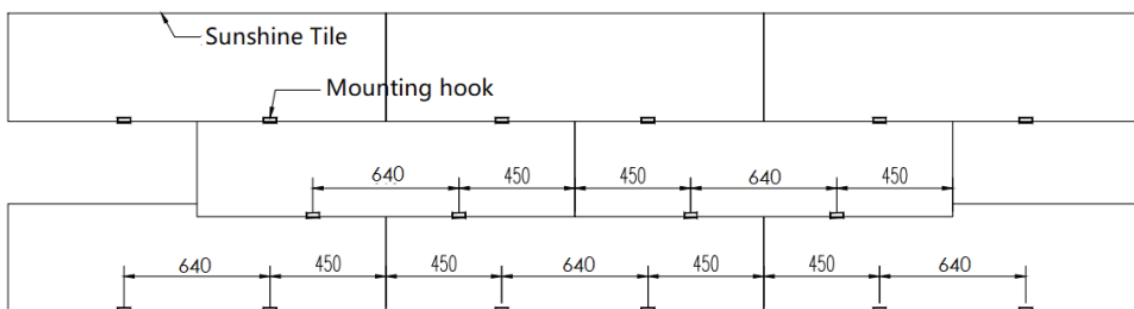

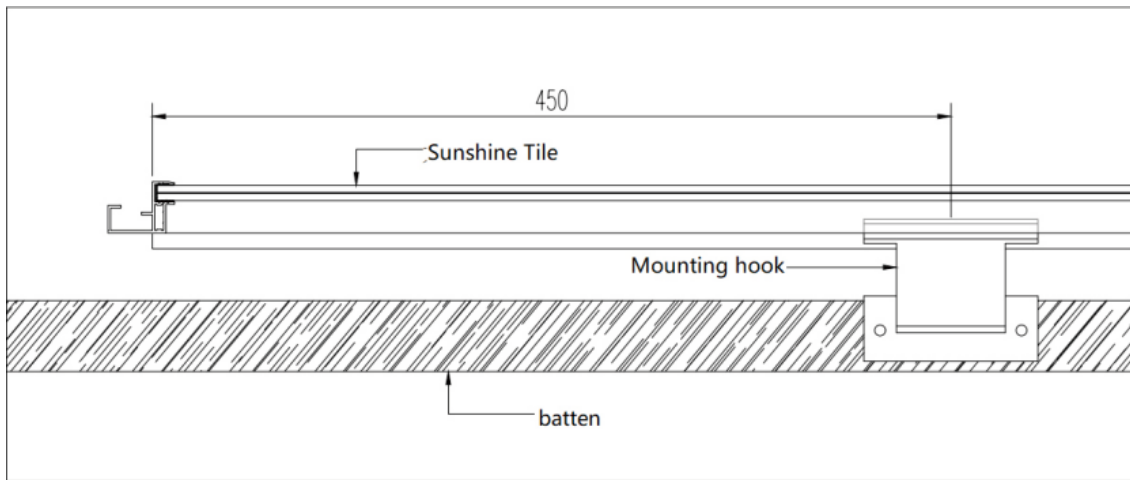

The center distance of the hook from the left edge of the Sunshine MH product is 450mm.

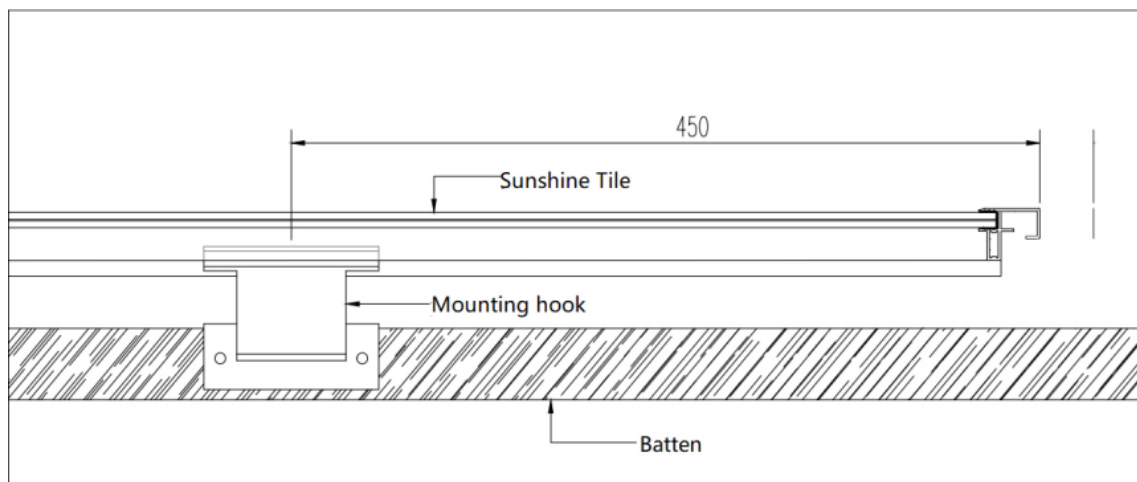

The center distance of the hook from the right edge of the Sunshine MH product is 450mm.

3. Once the installation hook position is confirmed, start with the bottom row and lay the installation hooks as shown in the figure.

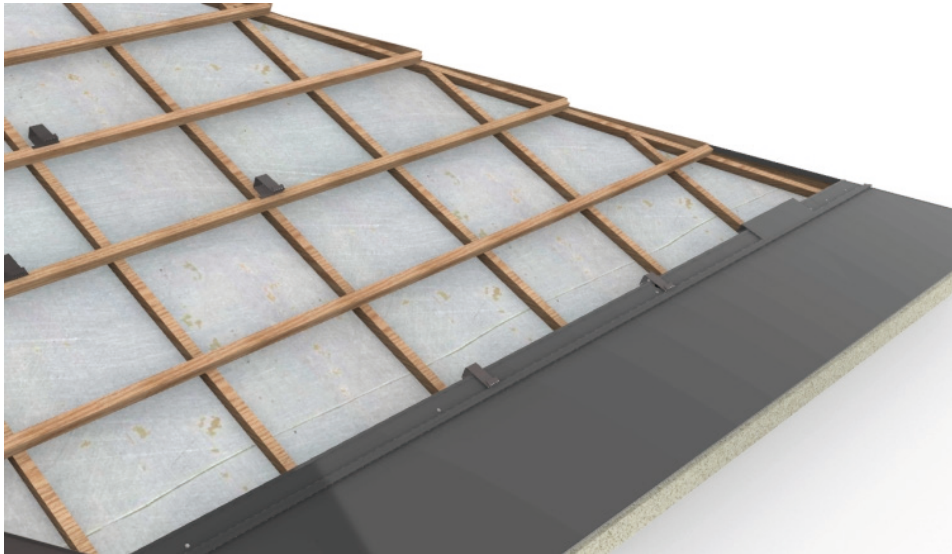

Layout of mounting hooks

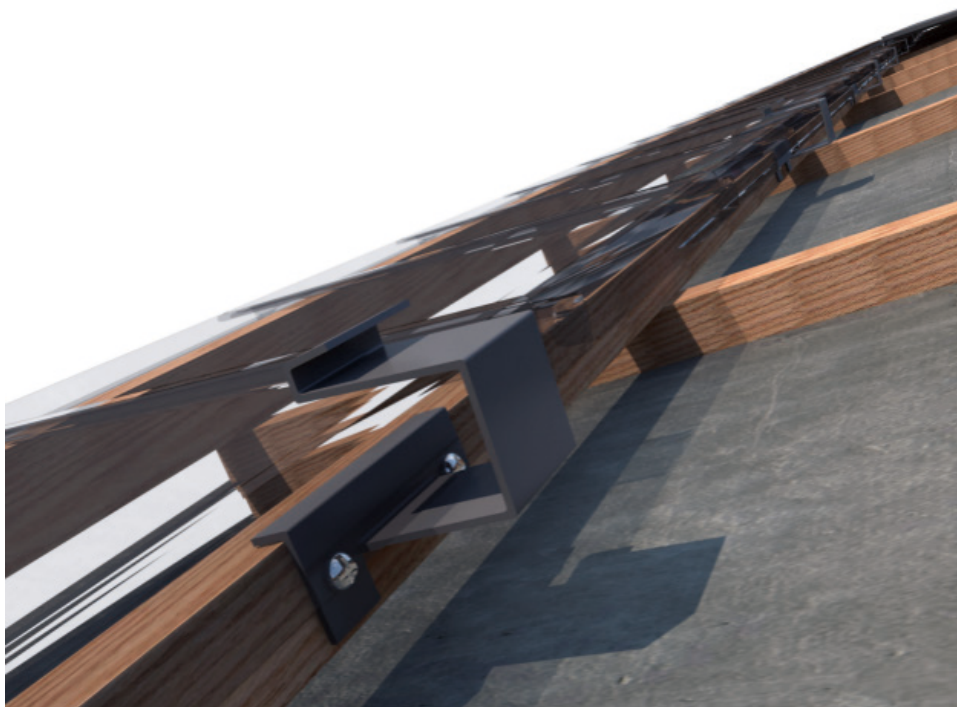

Layout of mounting hooks

4. After completing the installation of the hooks for the entire row of the Sunshine MH products, install the matching tiles on the right side of this row (as shown in the figure below

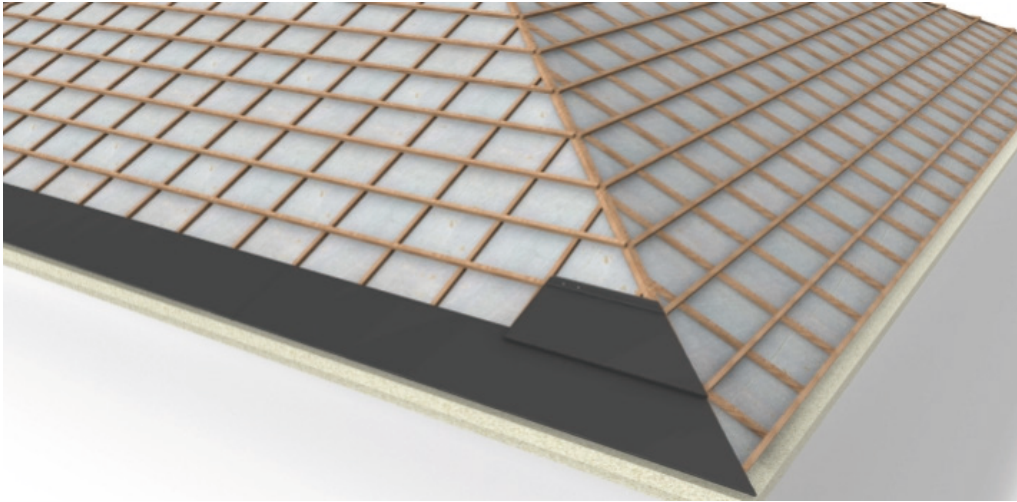

Installation of matching tiles on the right

5. After installing the right-side matching tile, continue to install the Sunshine MH products from right to left. Make sure all the products are correctly fitted into the installation hook slot. Then install the left-side matching tile to complete the installation of this row (as shown in the figure below).

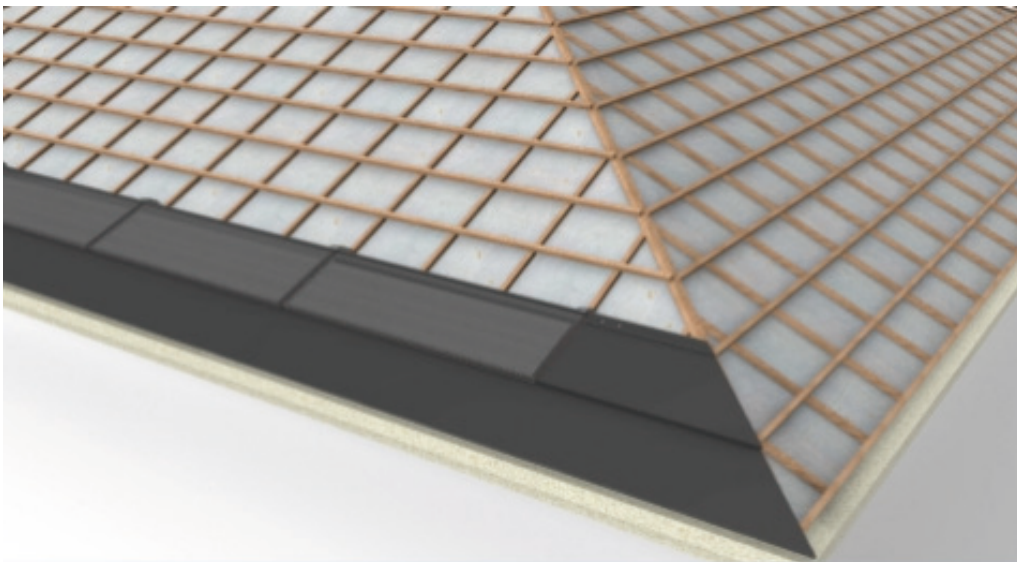

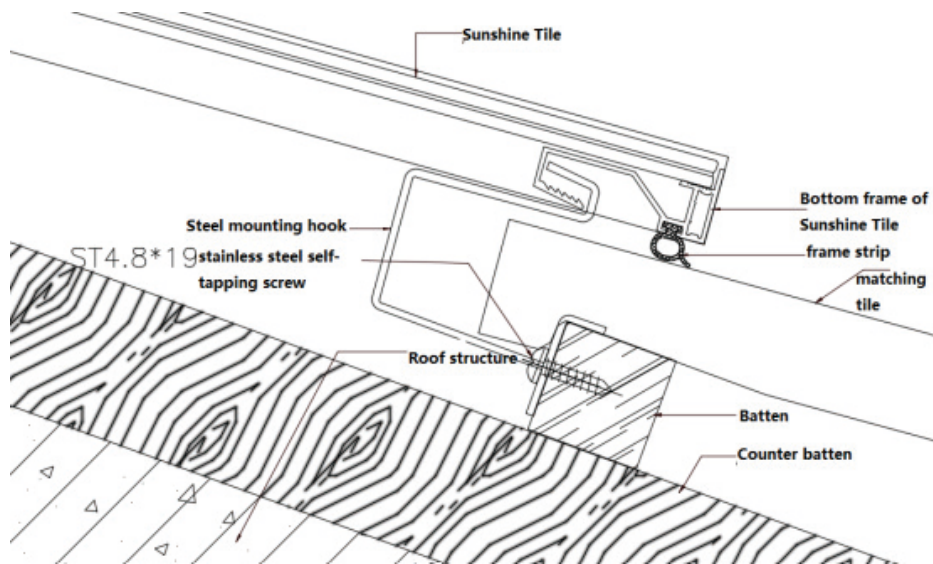

Installation of Sunshine MH products

6. The left and right overlaps of Sunshine MH products are as follows. The overlapping positions can be optionally fitted with plugs:

The overlap of the left and right frames of the Sunshine MH product

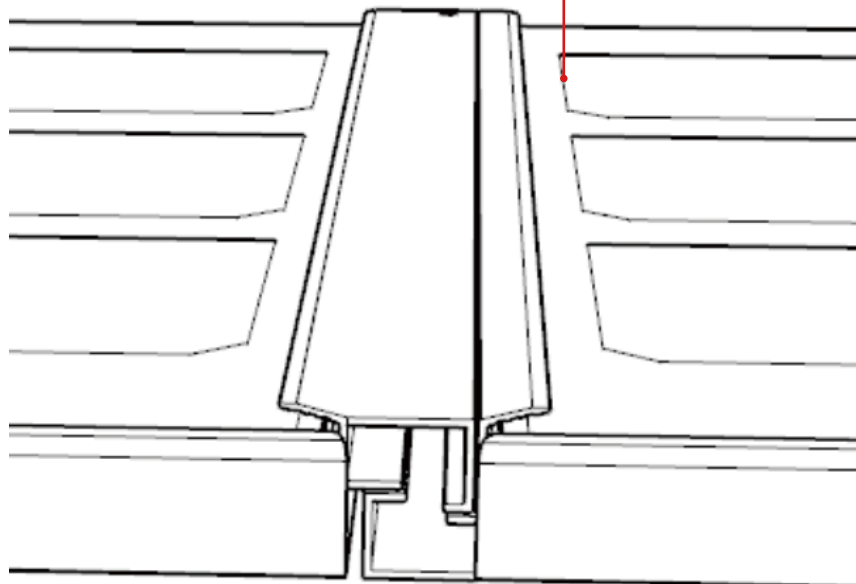

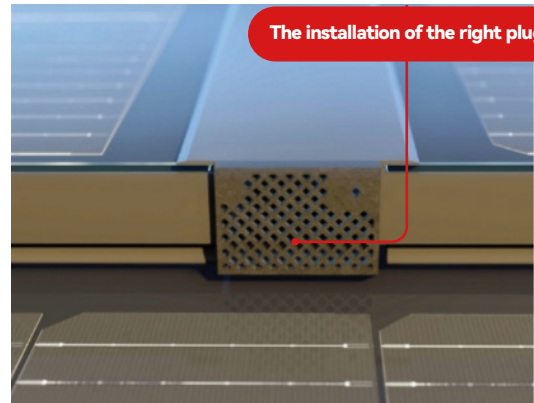
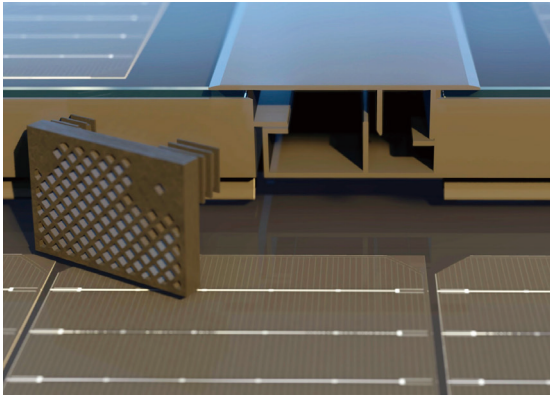

7. The matching tiles that directly overlap with the left and right frames of the Sunshine MH products must be fixed on the battens with self-tapping screws;
8. After completing the installation of the entire row of Sunshine MH products, proceed from bottom to top into the installation of the next row of Sunshine MH products. The installation method is the same as the previous row. The next row of Sunshine MH products partially overlaps with the products of the previous row (as shown in the figure).

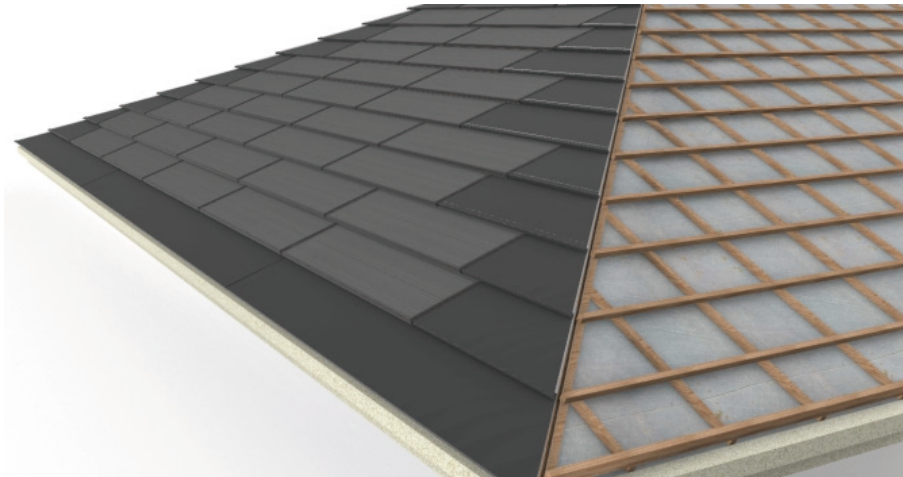

9. When regular Sunshine MH products are used with Type B Sunshine products, products in the same row should use the same version and different versions of products should be alternated in the form of rows.



10. After each row of Sunshine MH products is installed, the overlap with the previous row of Sunshine MH products should be checked to avoid covering the solar cells of the previous row of tiles. The overlap distance between upper and lower products should be $50\text{--}90\text{mm} \pm 5\text{mm}$ (as shown in the figure below).

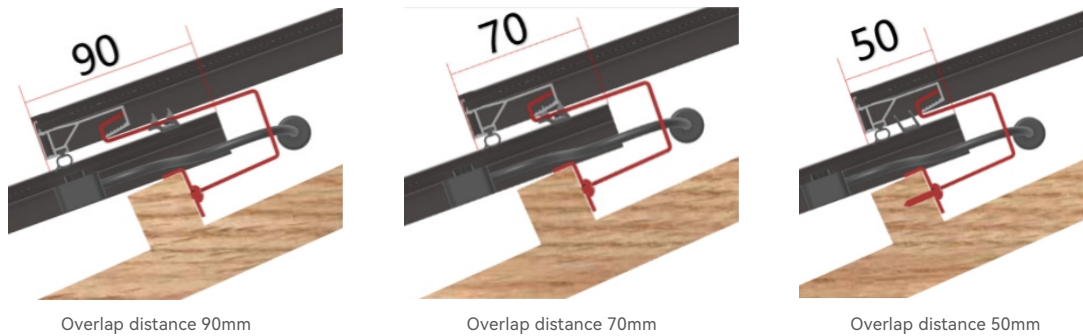

11. Install the Sunshine MH product and its matching tiles row by row from bottom to top until the entire roof is installed.



5.8 INSTALLATION OF LIGHTNING PROTECTION CONNECTION WIRES

1. Before installation, the grounding cables can be uniformly connected to the grounding hole on the left frame of the Sunshine MH product in the box. Install the external tooth washer, grounding cables, and self-tapping screws (with a diameter of $\geq 4.8\text{mm}$) in sequence, and tighten the screws.

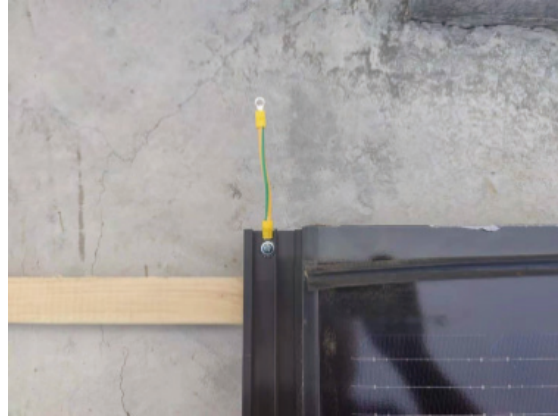

2. Finish the installation of a complete row of Sunshine MH products. Before installing the next row, pull out the end of the grounding cable (left side in the figure below) and connect the end of the grounding cable to the right frame of the Sunshine MH product at the overlapping position (right side in the figure below).

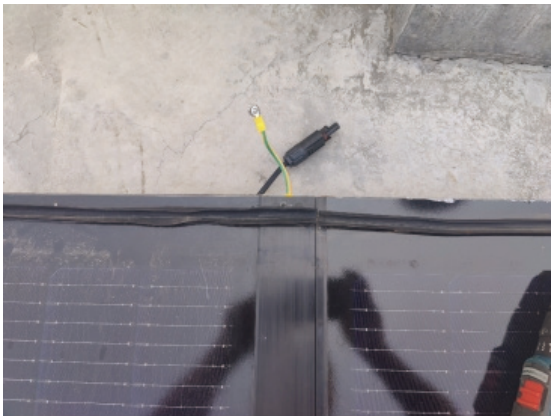

3. Before the installation of the next row, check whether the connection wire of the grounding hole is connected at the most two ends of this row of Sunshine MH products, and confirm that it is connected before installing the next row of Sunshine MH products.
4. Continuing with the installation of the Sunshine MH products on the next row, connect the frames of all rows using grounding cables in the manner shown in the diagram below. This will create a conductive pathway between all the frames of the Sunshine MH products, leading to a bus bar which will then be connected to the grounding flat iron. The grounding flat iron should be buried in the ground.



6

ELECTRICAL INSTALLATION

6.1 ELECTRICAL PROPERTY

- The nominal values of electrical performance parameters such as I_{sc} , V_{oc} and P_{max} of Sunshine MH product have an error of $\pm 3\%$ from those under standard test conditions. Standard test conditions for Sunshine MH product: irradiance 1000 W/m^2 , cell temperature 25°C , atmospheric mass AM 1.5.
- When Sunshine MH products are connected in series, the total voltage is the sum of the voltage of every single Sunshine MH product in the string, and when Sunshine MH products are connected in parallel, the final current is the sum of the current of every string of Sunshine MH products, as shown in Figure 6-1. Sunshine MH products of different electrical performance models should not be connected in one string.

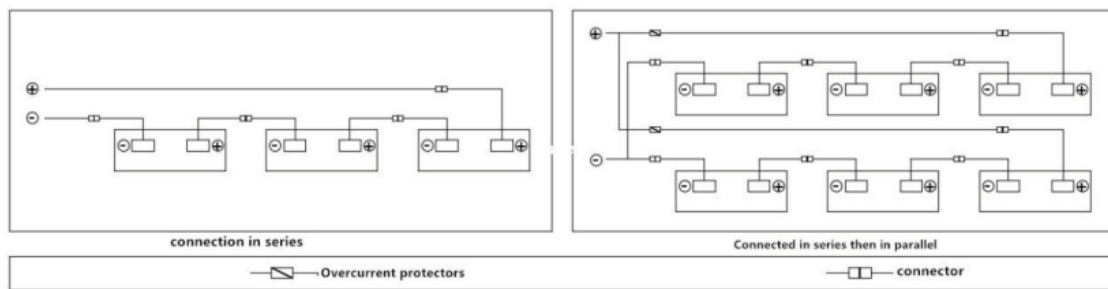

Figure 6-1 Series-parallel electrical diagram

- The maximum number of single strings of Sunshine MH products that can be connected in series must be calculated following the requirements of local electrical requirements and regulations. The value of its open-circuit voltage at the lowest expected local temperature conditions must not exceed the maximum system voltage value specified for Sunshine MH products (maximum system voltage for the products is DC1000V/DC1500V - the actual system voltage is designed according to the selection of the product models and inverters) and other values required for DC electrical components.
- The open circuit voltage correction factor can be calculated with the following formula:

$$CV_{oc} = 1 - \beta V_{oc} \times (25 - T)$$

Where T is the minimum ambient temperature expected at the system installation location and $\beta (\%/^\circ\text{C})$ is the temperature coefficient of the open circuit voltage of selected Sunshine MH products (refer to the corresponding Sunshine MH products parameter table).

- If a reverse current exceeding the maximum fuse current of the Sunshine MH product may pass through the product, an overcurrent protection device of the same size must be used to protect the product. If the number of parallel connections is more than or equal to 2 strings, there must be an overcurrent protection device on each string of the products, as shown in Figure 7-1.

6.2 CABLE AND GROUNDING CABLES

- Sunshine MH products shall be connected by using IP68-rated junction boxes, which shall provide safe protection for the conductors and their corresponding connections and accessible protection for non-insulated live parts. The junction box consists of a connected cable and IP68-rated connectors to facilitate the series connection between Sunshine MH products. A single product has two separate wires connected to two separate junction boxes, one positive and one negative. Two Sunshine MH products can be connected in series by inserting the positive connector into the socket of the negative connector of the adjacent product.
- Use dedicated solar cables and appropriate connectors (wires should be encased in UV-resistant conduit or, if exposed to air, should be age-resistant themselves) and ensure that the cables are electrically and mechanically sound, in accordance with local fire, building and electrical codes. Installers should only use single-core solar cables, 2.5–16mm² (5–14 AWG), 90°C rated, with appropriate insulation to withstand the maximum possible system open circuit voltage (as approved by EN 50618). Appropriate wire sizes need to be selected to minimize voltage drop. All wiring and electrical connections comply with the requirements of the appropriate National Electrical Code or standard. Avoid mechanical damage to the cable or Sunshine MH products when the cable is secured to the bracket. Do not press the cable with force. The cable shall be secured to the bracket by specially designed aging-resistant cable ties and wire clips. Although the cable is resistant to aging and water, it should be protected from direct sunlight and rain. The minimum bending radius of the cable should be 43mm.



Figure 6-2 Minimum bending radius of the cable

6.3 CONNECTOR

- Please keep the connector dry and clean, and make sure that the nut of the connector is tightened before connecting. Do not connect the connector when it is wet, dirty or in other unfavorable conditions. If the connector is not connected properly to the other polarity, the connector is not waterproof. It is necessary to connect or take appropriate measures to avoid the infiltration of water vapour and dust as soon as possible after the module is mechanically installed to the roof. Avoid having connectors exposed to direct sunlight and immersed in water. Avoid having connectors falling on the ground or on the roof. Incorrect connections may produce arcing and electric shock. Make sure all electrical connections are secure. Make sure that all connectors with locking are fully connected.
- It is not recommended that connectors of different models be connected and used together.

6.4 BYPASS DIODE

- The cell strings within a solar module are protected by bypass diodes in parallel and encapsulated in a junction box. When a hot spot phenomenon occurs locally in a module, the diode will activate so that string current no longer flows from the hot spot cells, thus limiting module heating and performance loss. Note that the bypass diode is not an overcurrent protection device. Contact the installer or system maintainer when a diode failure is detected or suspected. Do not attempt to open the module's junction box by yourself.

6.5 ELECTRICAL REQUIREMENTS FOR THE INSTALLATION OF SUNSHINE MH PRODUCTS

1. Inspection before installation
 - ① No visible defects.
 - ② Models and specifications should meet the requirements of the design drawings.
 - ③ Accessories and spare parts are available;
 - ④ For electrical parameters, please refer to the appendix product specification.
2. Preparation of main tools
 - ① Multimeter: For measuring the open-circuit voltage of Sunshine MH products.
 - ② Angle measuring instrument, level, etc.: measuring the installation angle of the Sunshine MH products array.
 - ③ Electric welding machine: for bracket lightning protection and grounding operations.
 - ④ Installation tools and spare parts are covered in Section 4.

6.6 MATERIAL PREPARATION

Please check whether the type and quantity of the arriving material are correct against the material list in the configuration sheet.

1. Sunshine MH product Electrical Wiring Requirements
 - ① Wiring with clear, unambiguous and easily understood wire number identification.
 - ② The jumper cable diameter must exceed the original Sunshine MH product cable diameter, and flame retardant and insulation performance should also be no less than that of the Sunshine MH product cable.
 - ③ The Sunshine MH products should be connected in the shortest way possible. When encountering Sunshine MH products that need to be connected over long distances, the total length of each set of serial connecting cables should be minimized as much as possible to minimize any differences in length.
 - ④ The wiring terminals should be in good contact. When connecting each part of the Sunshine MH product in series, it is best to test once each section is completed with a multi-meter to string connectivity.
2. Electrical wiring method of the Sunshine MH product
 - ① Wiring in accordance with the wiring in the electrical schematic.
 - ② For products connected in series, the "+" pole of one product is connected to the "-" pole of another product. Extension cables are required if the connection of products between different rows is needed. Please use extension cables that are for solar applications specifically. Under normal circumstances, the second row can be installed and wired only after the following row has been installed and wired.
 - ③ When installing Sunshine MH products of the same model, extension cables are required for cross-connections. Before moving on to the installation of the next row, one end of the extension cable should be connected and reserved, while the other end is led out to the position where the cross-connection is needed and left waiting for connection (as shown in Figure 6-3).

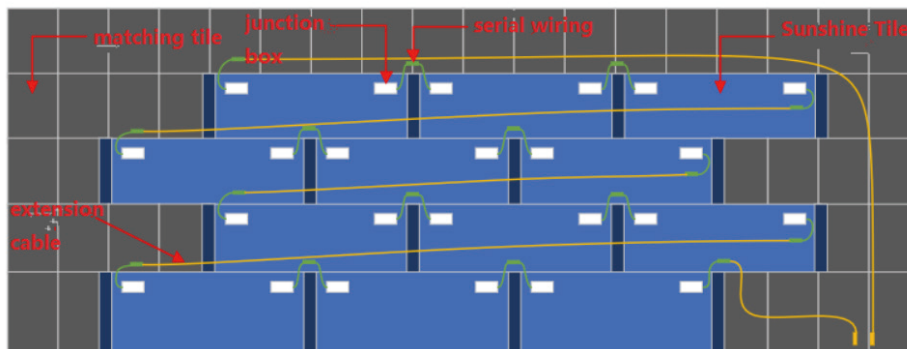

Figure 6-3 Operation instructions for connecting jumper cables to the same type of Sunshine MH product (back view of the roof).

- ④ When regular Sunshine MH products are used with Type B Sunshine, the same version should be installed in one row, and the next row should change to the other version, alternating in the form of rows. Before moving to the next row, connect and secure one end of the extension cable, leaving it ready, and route the other end to the required bridging position for connection (as shown in Figure 6-4).

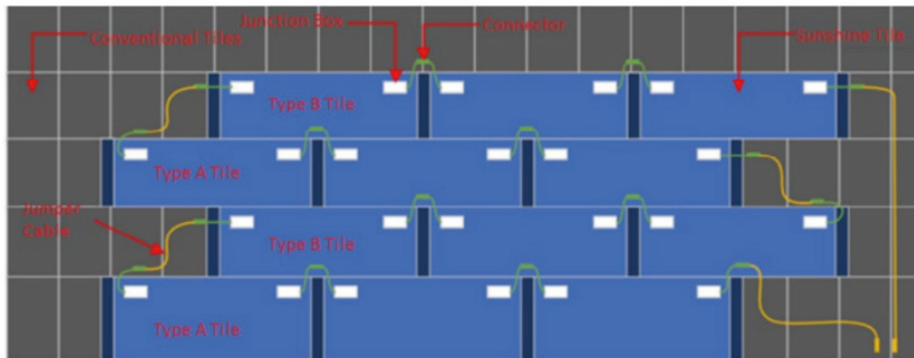

Figure 6-4: Instructions for Bridging Connection of Regular Sunshine MH products with Type B Sunshine MH products (Back View of Roof)

- ⑤ After connecting a group of series connections as shown in the drawing, connect the remaining group of "+" and "-" pole terminals to the inverter;

Note: This document only describes the wiring requirements and wiring principles. Since the roof of each site may not be the same, it is impossible to make uniform wiring regulations for each project. Wiring can be done later in accordance with the Sunshine MH product installation layout drawings in each project.

6.7 COMBINER KIT (CABLE AND TERMINAL) INSTALLATION REQUIREMENTS

- ① Connect the combiner kit to the Sunshine MH product array according to the electrical schematic.
- ② Ensure that the docking plug is fully inserted and the connection is secure.
- ③ The combiner kit can be fixed on the bracket, and the wiring should be neat and easy to maintain.
- ④ Avoid applying force to the cable during the connection of the cable to prevent friction from damaging the cable jacket due to wind-induced vibration.
- ⑤ After connecting the combiner kit's mating terminals, use Photovoltaic special crimping pliers to clamp the terminals at both ends, just like the mating terminals of the Sunshine MH product.

7

ELECTRICAL CONSTRUCTION PROCESS

7.1 CONSTRUCTION PROCESS

7.1.1 Operating conditions

- ① Assembly of product array is completed.
- ② Installation of inverter and distribution box is completed.

7.1.2 Preparation of main tools

- ① Impact drill: For drilling holes in the installation position of PVC and other line pipes and pipe cards.
- ② Crimper: For on-site DC cable splice plug production.
- ③ Multimeter, megohmmeter: For cable conduction and insulation testing.
- ④ Wire stripping pliers: for cable stripping.

7.1.3 Main Material

- ① DC cables for photovoltaics.
- ② AC cables.
- ③ Cable DC connectors use the same type of product or a compatible one which satisfies local standards and requirements.

7.1.4 Installation Engineering Process

Determine the cable run and AC/DC conduit requirement after on-site measurement.

- ① A conduit is required for cables between the array and inverter.
- ② Conduit is required for cables between the inverter and distribution box, distribution box and household electricity box.

7.1.5 Conduit laying requirements

- ① Follow local electrical standards and regulations when designing and laying the conduits, requirements of local standards and regulations prevail if contradictions are found. When laying electrical conduits on the wall, they should be laid in the corners of the wall, in the same direction as rainfall pipes and air-conditioning pipes.
- ② It is advisable to avoid the crossover of AC and DC directions in the piping between equipment.

7.1.6 Cable laying

Requirements for cable laying:

- ① When wiring each system, the type of conductor, voltage level, etc. are inspected according to the provisions of the current national standards.
- ② Remove water and debris from the conduit or wire channel before threading.
- ③ When using the crimping method to connect the wire, the specifications of the terminal copper sleeve crimp should be consistent with the cross-section of the cable core.
- ④ AC and DC cables should be run in different conduits to ensure safety.
- ⑤ After the cable is installed, the joints should be glued and sealed to prevent water from seeping into the conduit. The opening of exposed conduits should be plugged with a soft cloth to avoid the entry of foreign objects.

- ⑥ Cable bending radius $\geq 6D$.
- ⑦ Wiring through conduits to avoid high temperature heat generating objects as much as possible.
- ⑧ Conduits need to be secured by conduit clips.
- ⑨ The AC and DC cables connected to the inverter and distribution box should be marked with the cable number at both ends.

DC side cable connector installation.:

- ① Arrange cable connectors and pins according to their intended polarity.
- ② Strip the DC PV cable by using wire strippers according to the length of the copper core pins.
- ③ Insert the DC PV cable into the pins, and crimp the pins.
- ④ Insert the pins into the male and female connectors and fasten them with the special screw driver.
- ⑤ Plugging in the male and female cable connectors and testing the tightness of the connection.

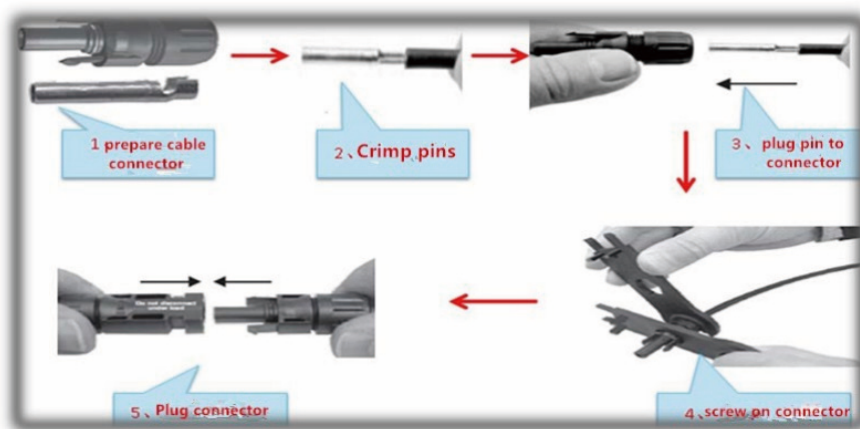

Figure 7-1 Cable connector production method

7.1.7 Sub-project requirements

- ① PVC flame-retardant rigid plastic pipe and its attached oxygen index should be 27% or more.
- ② Insulation of the cables should be tested before being threaded into conduits.
- ③ The minimum allowable bending radius of the cable laid through the pipe is six times of cable diameter.
- ④ The conduit clip spacing of exposed conduits should be:
 - a. $\Phi 20$ pipes are laid openly along the wall with a maximum distance of 1.5m between pipe clips;
 - b. $\Phi 25$ pipes are laid openly along the wall with a maximum distance of 2m between pipe clips.
 - c. Allowable value of deviation for the laying of open piping.

Straightness	<1.5mm/m
Verticality	<1.5mm/m

- ⑤ Cables from different circuits, different voltages or AC and DC cables, should not be worn in the same conduit.
- ⑥ There shall be no joints in the wires in the conduits.
- ⑦ Connect the plugs tightly.

7.2 LIGHTNING PROTECTION AND EARTHING

7.2.1 Lightning Protection

Refer to local lightning protection design specifications for buildings.

7.2.2 Functional grounding - Repeated grounding of distribution boxes and inverters

Functional earthing:

The distribution box and inverter should not be grounded repeatedly. Use tinned copper braided tape or soft copper wire to connect the grounding busbar of the equipment with the grounding electrode.

Note:

TCO effect: After running for a relatively short period, it was found that some thin-film modules experienced so-called TCO (transparent conductive oxide) layer damage. Once the conductive layer on the inside of the glass cover is damaged, it cannot be repaired and will cause significant power loss.

Ground resistance measurement: The requirement for the overall system grounding resistance value is no more than 4 ohms.

7.2.3 Pre-commissioning inspection

Correctly connect the Sunshine MH product array, inverter, and AC grid according to the installation process described above. Ensure that the AC and DC side voltages meet the machine startup conditions.

7.2.4 Sunshine MH product Array

Before the inverter is turned on, it is necessary to check the solar tile array on site and check whether the open-circuit voltage of each solar tile meets the requirements.

- ① Accurately record all values measured on site;
- ② Ensure correct polarity, otherwise the machine will be severely damaged;
- ③ Use a megohmmeter to test the insulation resistance of each solar tile array positive and negative pole to ground $>40\text{M}\Omega$.

7.3 SAFETY PRECAUTIONS:

1. Electrical operation requirements:
Requirements: Professional electricians and welders work with certification.
2. Direct current connection of Sunshine PV modules
 - ① Do not open the junction box on the back of the Sunshine MH product;
 - ② Do not touch the positive and negative poles of the Sunshine MH product directly with your hands;
 - ③ Do not directly unplug the positive and negative terminals of the string under power;
 - ④ Do not apply mechanical force to the wires on the back of the Sunshine MH product.
 - ⑤ After the DC cable is laid between the array and the inverter, measure the insulation resistance between the positive and negative poles to the ground to avoid grounding and electric shock accidents caused by cable sheath damage.
3. Inverter and distribution box-side connection
 - ① After the AC cable is laid, the insulation resistance between each phase, neutral, and ground should be measured first. After the measured resistance value is qualified, electrical commissioning can be performed;
 - ② When making cable heads, the stripping length should meet the construction process requirements, and the compression should be tight when entering the circuit breaker and power supply, without any loose connection.

8

REMOVAL AND MAINTENANCE

If a damaged or faulty Sunshine MH product needs to be replaced after installation, the damaged Tile must be repaired or replaced as soon as possible. Refer to the following detailed disassembly steps for Sunshine MH product repair and replacement.

When disassembling the Sunshine MH product, pay attention to slip prevention, wear slip-resistant shoes or slip-resistant shoe covers, and use a suction cup for disassembly and replacement.

8.1 REMOVAL OF SUNSHINE MH PRODUCTS

1. First, push the target Sunshine MH product upward to make the bottom of the solar panel fall out of the hook range. (As shown in the figure below)

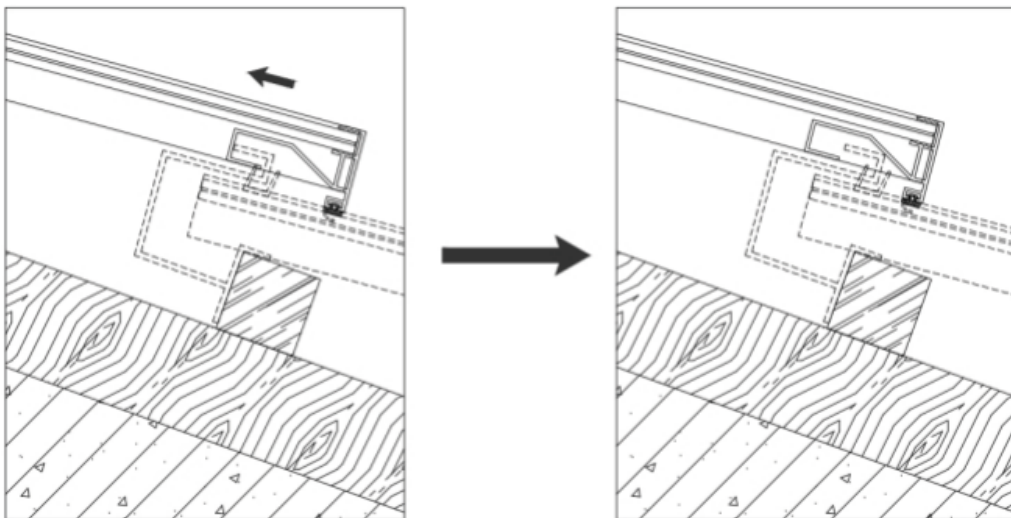

2. Lift the lower part of the target Sunshine MH product upward slightly. (as shown in the below figure)

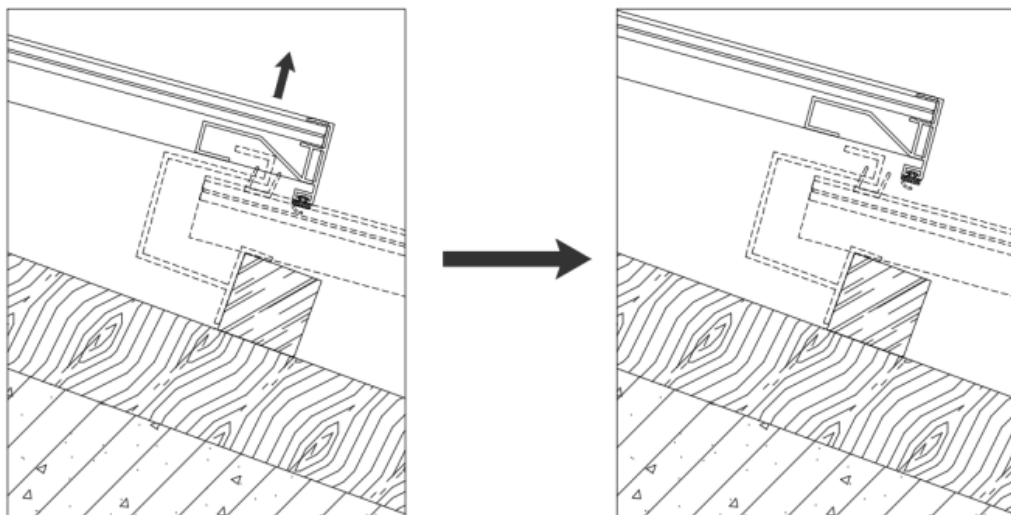

3. Gently pull the target Sunshine MH product downwards to expose the cable connector on the upper side of the tile; loosen the connector and remove the target Sunshine MH product as a whole. (See figure below)

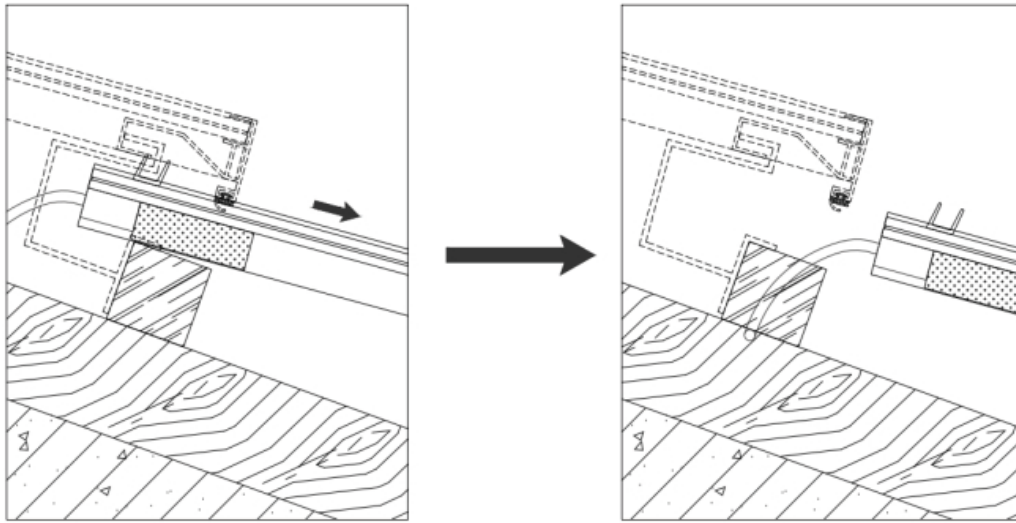

8.2 REPLACEMENT AND INSTALLATION OF SUNSHINE MH PRODUCTS

1. Lift the left side of the tile that needs to be replaced slightly.
2. Place the replacement Sunshine MH product to make it overlap with the surrounding tiles.
3. Connect the wires of the replacement Sunshine MH product firmly with those of the adjacent tiles, and check whether the circuit is intact.
4. Push the replacement Sunshine MH product upwards.
5. Lay the Sunshine MH product flat and move it downwards until it falls into the installation hook groove.
6. The replacement and installation procedure is now complete.

9

CAUTIONS

1. All electrical installations must comply with electrical installation standards and be installed by electrical professionals. Make sure that the input and output switches are in the off state.
2. DC input must never be connected to the inverter output terminal, and it is forbidden to short-circuit or ground the output circuit.
3. The wiring between the DC input and inverter should be as short as possible.
4. Different colour cables should be selected for distinction during the connection process. Connect the positive pole with a red cable and the negative pole with a blue cable.
5. To ensure the balance between each Sunlight Tile string, the selected DC cables should have the same cross-sectional area.
6. Before making electrical connections, be sure to cover the Sunlight Tiles with an opaque material or disconnect the DC-side circuit breaker. Exposed to sunlight, the Sunlight Tile array will generate dangerous voltages.
7. The grounding terminal of the system must be reliably grounded, and the grounding wire should be kept as short as possible. Do not connect it to the common ground of other high-current equipment such as welding machines and motors.